

LIQUID TIGHT INDUSTRIAL ENCLOSURES & ACCESSORIES



PAGE 7



PAGE 5

INTERNATIONAL APPROVALS



ISO 9001 Certified



PAGE 5



PAGE 7



PAGES 4 & 8



PAGE 2 & 3



**HI-TECH
CONTROLS, INC.**

14853 East Hinsdale Ave. Suite D
Centennial, CO 80112-4240, U.S.A
Phone: 303.680.5159 FAX: 303.680.5344
E-Mail: info@hitechcontrols.com
Web Site: www.hitechcontrols.com
Order Desk: 800.677.8942

LIQUID TIGHT POLYSTYRENE ENCLOSURES

for Indoor Installations



ORDER NUMBER (GREY)	BOX SIZE	DIMENSIONS						SIDE PANEL CONFIGURATION No. of Holes and Size	GROMMETS INCLUDED (IP 55, NEMA 12)	MOUNT WITH #8-UNC SCREWS
		INCHES			MM					
		W	H	D	W	H	D			
D 9020 D 9120	1	3.5 x 3.5 x 2.1	88 x 88 x 53	7 M20 7 M20	4 x ESM 20 (M20) 4 x ESM 20 (M20)	2 Inside Box 2 Outside Lugs				
D 8020 D 8120	1	3.5 x 3.5 x 2.1	88 x 88 x 53	Smooth Smooth	- -	2 Inside Box 2 Outside Lugs				
D 9040 D 8040	2	3.9 x 3.9 x 2.3	98 x 98 x 58	7 M25 Smooth	4 x ESM 25 (M25) -	2 Inside Box 2 Inside Box				
K 9060 K 8060	3	5.5 x 4.7 x 2.8	139 x 119 x 70	4 M25 + 6 M25/32 Smooth	3 x ESM 32 (M32) -	4 Inside Box 4 Inside Box				
K 9100 K 8100	4	6.6 x 4.9 x 3.2	167 x 125 x 82	10 M25/32 Smooth	3 x ESM 32 (M32) -	4 Inside Box 4 Inside Box				
K 9250 K 8250	5	7.9 x 6.3 x 3.9	200 x 160 x 98	10 M32/40 Smooth	3 x ESM 40 (M40) -	4 Inside Box 4 Inside Box				
K 9500 K 8500	6	12.2 x 8.3 x 4.6	310 x 210 x 116	10 M25/32 + 4 M40/50 Smooth	- -	4 Inside Box 4 Inside Box				

Reference our Web Site at www.hitechcontrols.com for our full product line & technical information!

For Strain Relief Fittings see Page 8 or Web Site!



Dimensions



DIN Rail



with Mounting Brackets

PAGE 3



NPT Hubs



Impact Resistant



UV Resistant

LIQUID TIGHT POLYCARBONATE ENCLOSURES

HALOGEN FREE for Outdoor and Harsh Environments (Impact & UV Resistant)



ORDER NUMBER (GREY)	ORDER NUMBER (BLACK)	BOX SIZE	DIMENSIONS						SIDE PANEL CONFIGURATION No. of Holes and Size	MOUNT WITH #8-UNC SCREWS
			INCHES			MM				
			W	H	D	W	H	D		
KF 9020 KF 8020	KF 5020 -	1	3.5 x 3.5 x 2.1	88 x 88 x 53	7 M20 Smooth	2 Inside Box 2 Inside Box				
KF 9040 KF 8040	KF 5040 -	2	3.9 x 3.9 x 2.3	98 x 98 x 58	7 M25 Smooth	2 Inside Box 2 Inside Box				
KF 9060 KF 8060	KF 5060 -	3	5.5 x 4.7 x 2.8	139 x 119 x 70	4 M25 + 6 M25/32 Smooth	4 Inside Box 4 Inside Box				
KF 9100 KF 8100	KF 5100 -	4	6.6 x 4.9 x 3.2	167 x 125 x 82	10 M25/32 Smooth	4 Inside Box 4 Inside Box				
KF 9250 KF 8250	KF 5250 -	5	7.9 x 6.3 x 3.9	200 x 160 x 98	10 M32/40 Smooth	4 Inside Box 4 Inside Box				
KF 9500 KF 8500	KF 5500 -	6	12.2 x 8.3 x 4.6	310 x 210 x 116	10 M25/32 + 4 M40/50 Smooth	4 Inside Box 4 Inside Box				

Reference our Web Site at www.hitechcontrols.com for our full product line & technical information!

For Strain Relief Fittings see Page 8 or Web Site!

SPECIFICATIONS

- Liquid Tight:** NEMA 4x (IP65)
- Temperature:** -40°F to 212°F (-40°C to 100°C)
- Cover Screws:** 304 Stainless Steel
- Cover Seal:** TPE (Thermoplastic Elastomer)
- Max. Voltage:** 670 V

	D/K SERIES	KF SERIES
MATERIAL:	Polystyrene	Polycarbonate (glass fiber reinforced)
COLOR:	Grey RAL 7035 N/A	Grey RAL 7032 Black RAL 9011

Enclosure Sides: With Metric knock-outs or smooth for custom drilling. The knock-outs for Metric threads have the following diameters: M20 = .79", M25 = .98", M32 = 1.26", M40 = 1.57", M50 = 1.97".



LISTED LIQUID TIGHT POLYCARBONATE ENCLOSURES

HALOGEN FREE for Outdoor and Harsh Environments (Impact & UV Resistant)



C_{UL} (meets SP requirements, tested by UL) listed enclosures with smooth sides and external mounting provisions can be used with DIN rail or mounting plate. The mounting brackets and hardware are also available as a kit. Order Number DK AL 2 to convert a standard series KF 8000 enclosure into a C_{UL} listed enclosure (1 – 5 only).

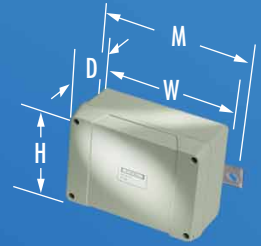

Reference our Web Site at www.hitechcontrols.com for our full product line & technical information!

For Strain Relief Fittings see Page 8 or Web Site!

ORDER NUMBER	BOX SIZE	DIMENSIONS								SIDE PANEL CONFIGURATION	MOUNT WITH #8-UNC SCREWS
		INCHES				MM					
		W	H	D	M	W	H	D	M		
KF 7020	1	3.5	3.5	x 2.1	4.46	88	x 88	x 53	113	Smooth	2 Brackets
KF 7040	2	3.9	3.9	x 2.3	4.74	98	x 98	x 58	121	Smooth	2 Brackets
KF 7060	3	5.5	4.7	x 2.8	6.47	139	x 119	x 70	164	Smooth	2 Brackets
KF 7100	4	6.6	4.9	x 3.2	7.57	167	x 125	x 82	192	Smooth	2 Brackets
KF 7250	5	7.9	6.3	x 3.9	8.87	200	x 160	x 98	225	Smooth	4 Brackets

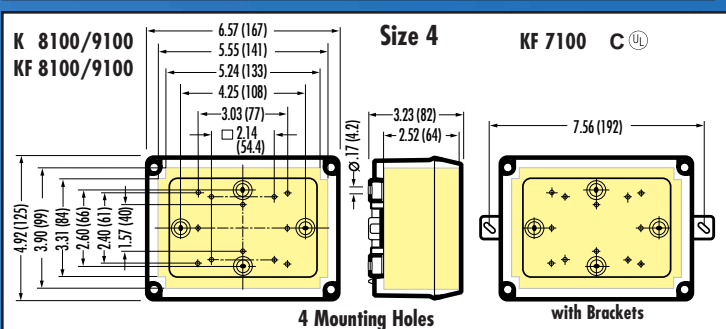
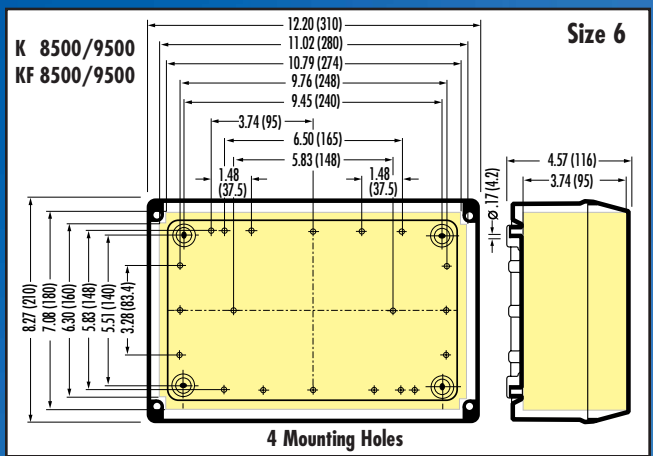
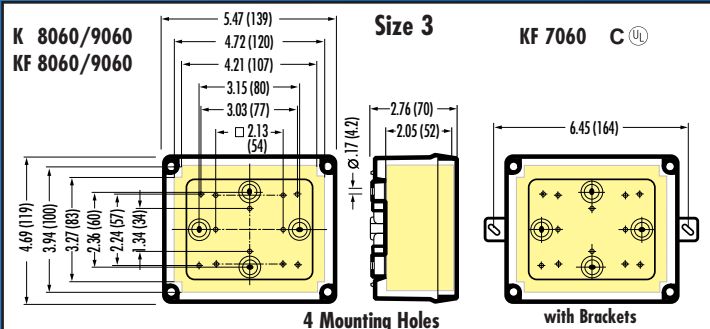
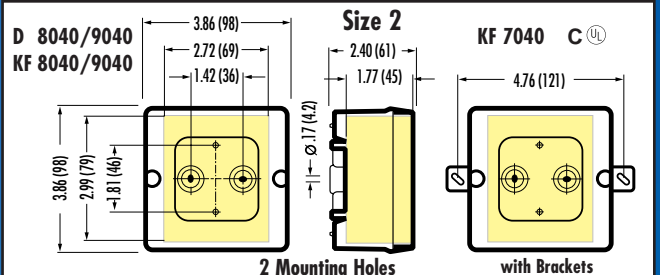
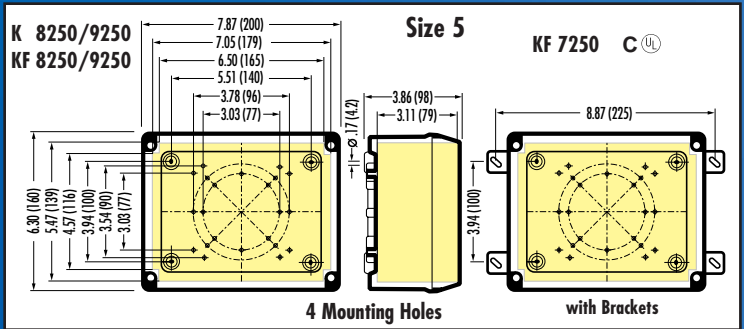
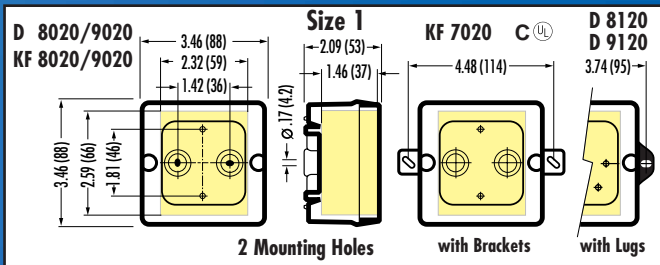

Notes:

1. Knock-outs are liquid tight until punched out with screwdriver. (See page 6).
2. Smooth sides can be drilled, punched or milled. NPT hubs are available.
3. Yellow shaded area is useable space in enclosure.
4. Mounting screws are #8 UNC (.16" ϕ). If used indoors, punch or drill holes and cap recess with rubber plugs located inside cover.

For D, K and KF Series

MOUNTING PLATES

(for box sizes 3 to 6)

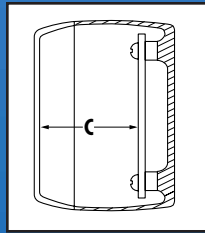
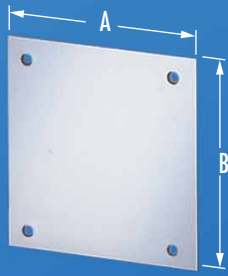

Allows easy installation of components outside of enclosure. Kit includes $\frac{1}{8}$ " plate, $\frac{3}{16}$ " stand-offs and mounting screws.

BOX SIZE	ORDER NUMBER	SIZE A x B in (mm)	CLEARANCE C in (mm)
3	K MP 06	4.0 x 3.0 (101 x 76)	1.65 (42)
4	K MP 10	5.0 x 3.5 (127 x 89)	2.13 (54)
5	K MP 25	6.3 x 4.8 (160 x 122)	2.72 (69)
6	K MP 55	10.0 x 6.5 (254 x 165)	3.35 (85)

For D, K and KF Series

DIN RAILS

CE-HAR-VDE

EN 50 022 (35 mm) **EN 50 045 (15 mm)**

Meets all European and US standards. Used with snap-on terminal blocks, relays etc. Kit includes rail and screws.

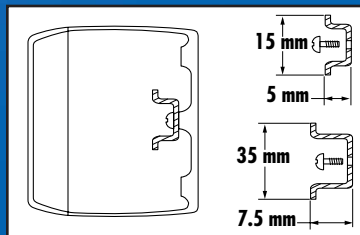

BOX SIZE	ORDER NUMBER	RAIL SIZE (mm)	RAIL LENGTH in (mm)
1	TSD 02	15	2.24 (57)
2	TSD 04	15	3.23 (82)
3	TSK 06	35	4.13 (105)
4	TSK 10	35	6.02 (153)
5	TSK 25	35	7.01 (178)
6	TSK 50	35	11.42 (290)

For D, K and KF Series

TERMINAL BLOCKS

CE-HAR-VDE

Meets all European and US standards. Plug or screw terminal blocks into holes inside enclosure. Provides clean power distribution. Maximum Voltage = 600V.

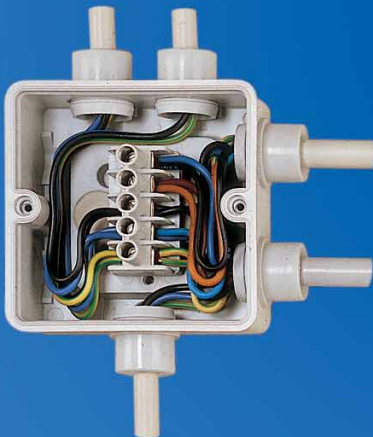

BOX SIZE	ORDER NUMBER	NO. OF POLES	NUMBER AND SIZE WIRE PER POLE (mm ²)	MAX. POWER (Amp.)
1 & 2	DKL 04	5	3 x 4.0, 4 x 2.5, 6 x 1.5	35
3	KKL 06	5	3 x 6.0, 4 x 4.0, 4 x 2.5	40
4	KLS 10	5	4 x 10.0, 4 x 6.0, 4 x 4.0	63
5 & 6	KLS 25	5	4 x 25.0, 4 x 16.0, 4 x 10.0	102
6	KLS 54	4	4 x 70.0, 4 x 50.0, 4 x 35.0, 4 x 25.0, 4 x 16.0	216
6	KLS 55	5	4 x 50.0, 4 x 35.0, 4 x 25.0, 4 x 16.0	170



DKL 04



KKL 06



KLS 10



KLS 25



KLS 54



KLS 55

HUB KITS — METRIC TO NPT

Hub Kits include NPT adapter and nut. Fits knock-out in box. Converts hole which fits Metric thread to a female NPT threaded hub.

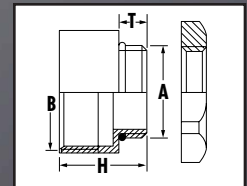

Materials:

Body & Nut: Nickel Plated Brass
O-Ring: Buna-N

ORDER NUMBER	MALE THREAD A	FEMALE THREAD B	WRENCHING FLATS W	THREAD LENGTH T	HEIGHT H
AM-2012-BR-N	M20 x 1.5	1/2" NPT	.94	.24	.91
AM-2512-BR-N	M25 x 1.5	1/2" NPT	1.18	.28	.59
AM-2534-BR-N	M25 x 1.5	3/4" NPT	1.18	.28	1.02
AM-3210-BR-N	M32 x 1.5	1" NPT	1.57	.32	1.22
AM-3254-BR-N	M32 x 1.5	1-1/4" NPT	1.77	.32	1.34

Mi LIQUID TIGHT MODULAR POLYCARBONATE ENCLOSURES



Hinges available for all sizes!

See page 8 or Web site for our Strain Relief solution!

Various sizes can be combined to make larger enclosures. The intermediate walls can be knocked out. Made of impact resistant polycarbonate, these enclosures meet NEMA 4x (IP 65) but have only a limited UV resistance. If used outdoors, protection against direct sunlight should be provided. All enclosures are available with transparent or opaque covers. Cover screws can be replaced with a special hinged screw to convert any size into an enclosure with hinged cover. More information about the system and the many accessories, such as connection kits, grommets and strain relief fittings are available in the MASTER CATALOG or check our web site: www.hitechcontrols.com

SPECIFICATIONS

Temperature Range: -40°F to 158°F (-40°C to 70°C)
Material: Polycarbonate
 Limited UV resistance
 Halogen and silicone free

Protection: NEMA 4x (IP65)

Notes:

1. Dimensions are in inches (mm).
2. Yellow shaded area is useable space in enclosure.
3. Knock-outs are liquid tight until punched out.
4. Enclosure mounting holes for M6 or 12-24 UNC screws are located below the cover mounting screws.

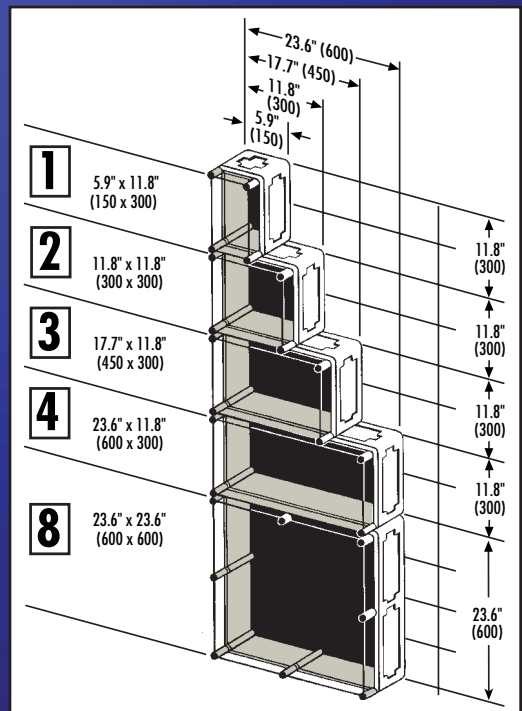
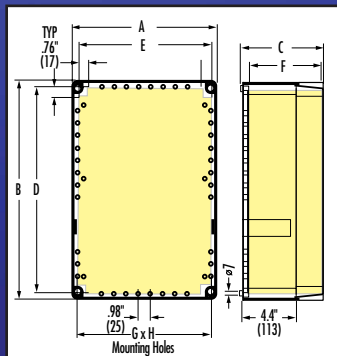
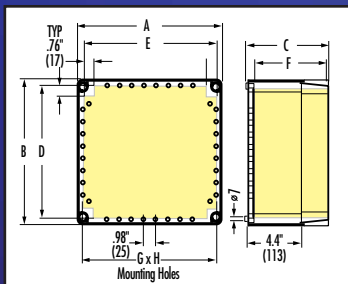

BASIC SIZE	ORDER NUMBER		DIMENSIONS INCHES (MM)							
	COVER TRANSP.	COVER OPAQUE	ENCLOSURE SIZE			INTERNAL SPACE			MOUNTING HOLES	
			A - LENGTH	B - WIDTH	C - DEPTH	D - LENGTH	E - WIDTH	F - DEPTH	G	H
1	Mi 0100	Mi 0101	11.8 (300)	5.9 (150)	6.7 (170)	4.8 (122)	10.7 (272)	5.7 (146)	10.8 (275)	4.9 (125)
2	Mi 0200	Mi 0201	11.8 (300)	11.8 (300)	6.7 (170)	10.7 (272)	10.7 (272)	5.7 (146)	10.8 (275)	4.9 (125)
2	Mi 0210	Mi 0211	11.8 (300)	11.8 (300)	8.4 (214)	10.7 (272)	10.7 (272)	7.5 (191)	10.8 (275)	10.8 (275)
2*	Mi 0220	Mi 0221	11.8 (300)	11.8 (300)	7.2 (182)	10.7 (272)	10.7 (272)	4.5 (115)	10.8 (275)	10.8 (275)
3	Mi 0300	Mi 0301	11.8 (300)	17.7 (450)	6.7 (170)	16.6 (422)	10.7 (272)	5.7 (146)	10.8 (275)	16.7 (425)
3	Mi 0310	Mi 0311	11.8 (300)	17.7 (450)	8.4 (214)	16.6 (422)	10.7 (272)	7.5 (191)	10.8 (275)	16.7 (425)
4	Mi 0400	Mi 0401	11.8 (300)	23.6 (600)	6.7 (170)	22.5 (572)	10.7 (272)	6.7 (170)	10.8 (275)	20.6 (525)
4	Mi 0410	Mi 0411	11.8 (300)	23.6 (600)	8.4 (214)	22.5 (572)	10.7 (272)	8.4 (214)	10.8 (275)	20.6 (525)
8	Mi 0800	Mi 0801	23.6 (600)	23.6 (600)	6.7 (170)	22.5 (572)	22.5 (572)	5.7 (146)	20.6 (525)	20.6 (525)

*Note: Mi 0220 and Mi 0221 feature a hinged cover.

For Mi Series

MOUNTING PLATES

Made of 5/32" (4 mm) insulating material. 4 screws included. Components can be installed with self-tapping screws.



ORDER NUMBER	BASIC SIZE	DIMENSIONS in (mm)
Mi MP 1	1, 3, 4	10.2 x 4.5 (259 x 115)
Mi MP 2	2 to 8	10.4 x 10.4 (265 x 265)
Mi MP 3	3, 4	10.4 x 16.3 (265 x 415)
Mi MP 4	4, 8	10.4 x 22.2 (265 x 565)
Mi MP 8	8	22.2 x 22.2 (565 x 565)



For Mi Series

EXTENSION FRAME

Increases the depth of enclosures 4 and 8 by 3.3" (85 mm). Mounting hardware included.



ORDER NUMBER	BASIC SIZE	DIMENSIONS in (mm)
Mi ZR 4	4	11.8 x 23.6 (300 x 600)
Mi ZR 8	8	23.6 x 23.6 (600 x 600)



For Mi Series

DIN RAILS EN 50 022 (35 mm)



ORDER NUMBER	BASIC SIZE	DIMENSIONS in (mm)
Mi TS 30	1 to 8	11.2 (284)
Mi TS 45	3	17.1 (434)
Mi TS 60	4, 8	23.0 (584)

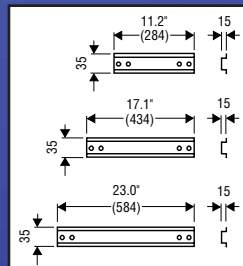

For components with clip-on or clamp attachment. Mounting screws are included.

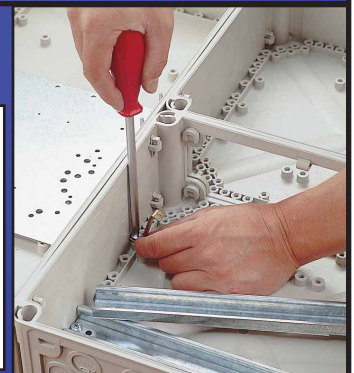

KNOCK-OUTS

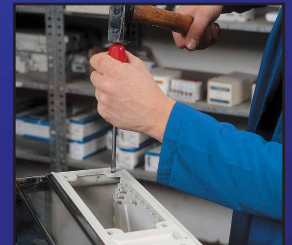
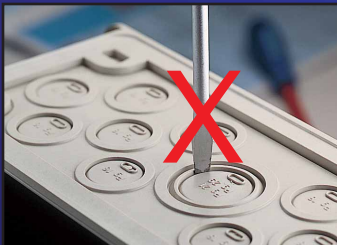

KG/KV LIQUID TIGHT ENCLOSURES

The KG & KV Series have transparent covers with special saddle shaped sides allows easy observation and quick access to the installed components. Only, KG Series is hinged! The housing is made of polystyrene, the cover is made of impact resistant polycarbonate. These enclosures meet NEMA 4x (IP 65). Four different sizes are available along with DIN rails and mounting plates.

KG 9001



Hinged

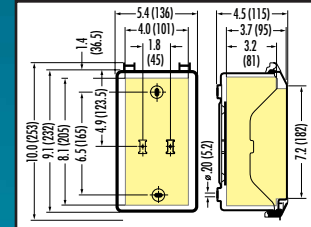
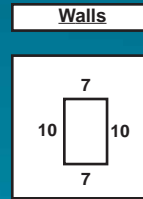
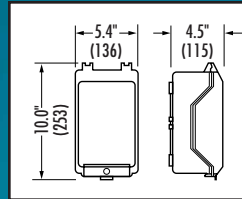

KG 9002



Hinged

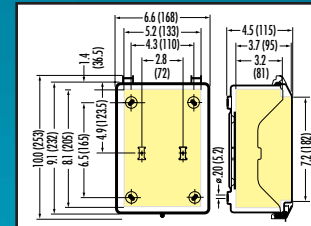
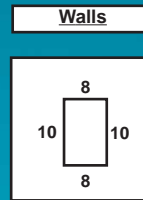
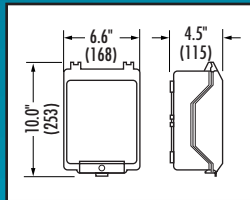

KG 9003



Hinged

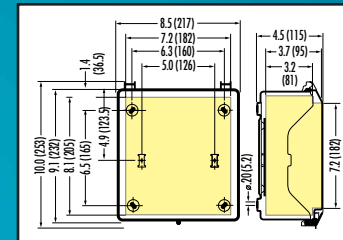
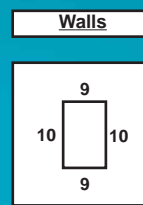
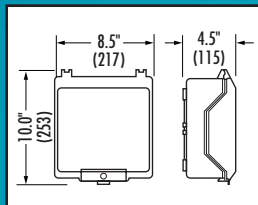

KV 9331

Included:
Mounting Plate



Not Hinged

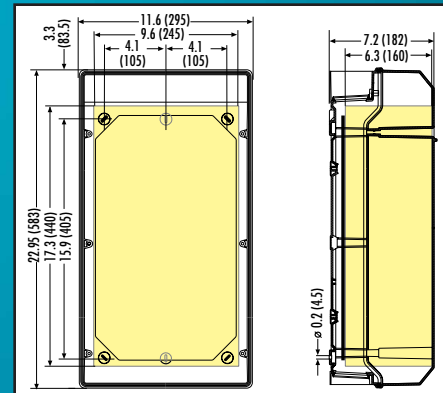
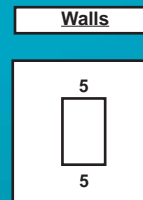
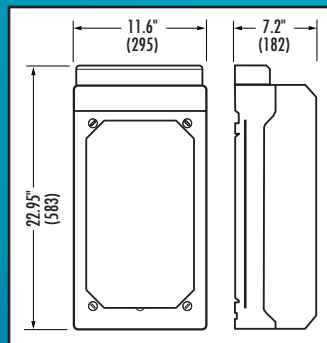

SPECIFICATIONS

Temperature Range: -40°F to 158°F (-40°C to 70°C)
Material: Housing: Polystyrene
Cover: Polycarbonate
Protection: NEMA 4x (IP65)

Notes:

1. Dimensions are in inches (mm).
2. Yellow shaded area is useable space in enclosure.
3. Knock-outs are liquid tight until punched out with screwdriver. (See page 6.)
4. Mounting holes for M4 or #8 screws are inside the enclosure. Punch or drill holes and cap recess with rubber plugs (Encl.).

INTEGRATED ELASTIC MEMBRANES FOR CABLE FEED-THROUGH.

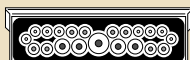

Wall 5:
 8 x ∅ 7 - 12 mm
 8 x ∅ 7 - 14 mm
 1 x ∅ 11 - 20 mm
 1 x ∅ 10 - 20 mm



Wall 7:
 2 x M20
 2 x M25
 1 x M32/40



Wall 8:
 4 x M20
 2 x M25/32
 1 x M32/40



Wall 9:
 6 x M20
 2 x M25/32
 1 x M32/40



Wall 10:
 2 x PG16

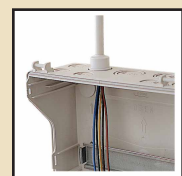

Grommets
ESM - IP 55

For KG Series

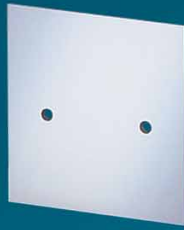

MOUNTING PLATES

Made of 5/32" (4 mm) plastic material. 4 Screws included.
Components can be installed with self-tapping screws.

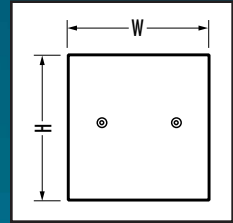

ORDER NO.	ENCLOSURE	W X H inches (mm)
KG MP 01	for KG 9001	3.9" x 5.4" (100 x 136)
KG MP 02	for KG 9002	5.1" x 5.4" (130 x 136)
KG MP 03	for KG 9003	7.1" x 5.4" (180 x 136)

For KG Series



DIN RAILS EN 50 022 (35 mm)

For components with clip-on or clamp attachment.
Mounting screws are included.

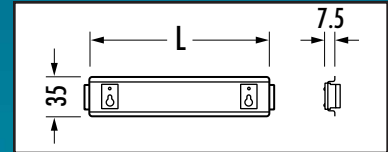

ORDER NO.	ENCLOSURE	LENGTH L inches (mm)
KG TS 01	for KG 9001	3.2" (81)
KG TS 02	for KG 9002	4.3" (108)
KG TS 03	for KG 9003	6.4" (162)

LIQUID TIGHT NYLON STRAIN RELIEF FITTINGS

Meet NEMA 4x (IP 65) & NEMA 6 (IP 68)

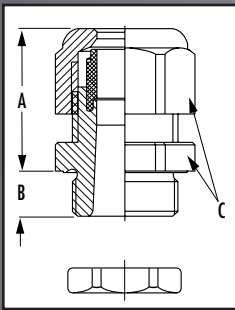

*Note: Locking nut is included.

ORDER NUMBER*		THREAD	CABLE RANGE INCHES (MM)	DIMENSIONS INCHES (MM)		
BLACK	GRAY			A	B	C
CD20MA-BK-N	CD20MA-GY-N	M20	.24 - .47 (6.0 - 12.0)	1.06 (27.0)	.35 (9.0)	.94 (24.0)
CD20MR-BK-N	CD20MR-GY-N		.20 - .35 (5.0 - 9.0)			
CD22MA-BK-N	CD22MA-GY-N	M20	.39 - .55 (10.0 - 14.0)	1.10 (28.0)	.35 (9.0)	1.06 (27.0)
CD22MR-BK-N	CD22MR-GY-N		.28 - .47 (7.0 - 12.0)			
CD25MA-BK-N	CD25MA-GY-N	M25	.51 - .71 (13.0 - 18.0)	1.22 (31.0)	.43 (11.0)	1.30 (33.0)
CD25MR-BK-N	CD25MR-GY-N		.35 - .63 (9.0 - 16.0)			
CD32MA-BK-N	CD32MA-GY-N	M32	.71 - .98 (18.0 - 25.0)	1.54 (39.0)	.43 (11.0)	1.65 (42.0)
CD32MR-BK-N	CD32MR-GY-N		.51 - .79 (13.0 - 20.0)			
CD40MA-BK-N	CD40MA-GY-N	M40	.86 - 1.26 (22.0 - 32.0)	1.89 (48.0)	.51 (13.0)	2.09 (53.0)
CD40MR-BK-N	CD40MR-GY-N		.79 - 1.02 (20.0 - 26.0)			
CD50MA-BK-N	CD50MA-GY-N	M50	1.26 - 1.50 (32.0 - 38.0)	1.93 (49.0)	.51 (13.0)	2.36 (60.0)
CD50MR-BK-N	CD50MR-GY-N		.98 - 1.22 (25.0 - 31.0)			

For other Strain Relief Products call Sealcon at 800.456.9012 or 303.699.1135. Visit Sealcon's Web site www.sealconusa.com or E-Mail info@sealconusa.com

GROMMETS NEMA 4x & 12 (IP 65)

Material: Thermoplastic Elastomer

Cut out scored center. Push cable through grommet. Features a double seal.
Does not provide strain relief for the cable. Can be used to plug a hole.

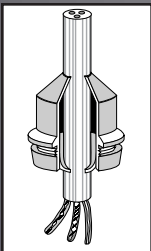
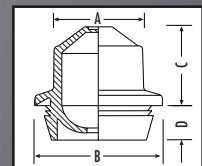

ORDER NUMBER	PANEL HOLE		PANEL WALL THICKNESS	CABLE RANGE INCHES (MM)	DIMENSIONS INCHES (MM)			
	BASIC	DRILLED			A	B	C	D
EDK 20	M20	.81 (20.5)	.06 - .14 (1.5 - 3.5)	.24 - .51 (6.0 - 13.0)	.73 (18.5)	1.02 (26.0)	.57 (14.5)	.33 (8.5)
EDK 25	M25	1.00 (25.5)	.06 - .14 (1.5 - 3.5)	.35 - .67 (9.0 - 17.0)	.93 (23.5)	1.22 (31.0)	.57 (14.5)	.33 (8.5)
EDK 32	M32	1.28 (32.5)	.06 - .14 (1.5 - 3.5)	.47 - .91 (12.0 - 23.0)	1.20 (30.5)	1.50 (38.0)	.77 (19.5)	.33 (8.5)
EDK 40	M40	1.59 (40.5)	.06 - .14 (1.5 - 3.5)	.67 - 1.18 (17.0 - 30.0)	1.52 (38.5)	1.81 (46.0)	.77 (19.5)	.33 (8.5)

STEPPED GLANDS NEMA 2 (IP 54)

Material: Thermoplastic Elastomer

Cut off appropriate step to fit cable. Push cable through gland. Does not provide strain relief for the cable. Can be used to plug a hole.

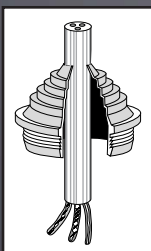
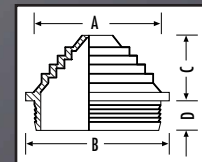

ORDER NUMBER	PANEL HOLE		PANEL WALL THICKNESS	CABLE RANGE INCHES (MM)	DIMENSIONS INCHES (MM)			
	BASIC	DRILLED			A	B	C	D
STM 20	M20	.81 (20.5)	.06 - .16 (1.5 - 4.0)	.20 - .63 (5.0 - 16.0)	.71 (18.0)	.98 (25.0)	.36 (9.2)	.31 (8.0)
STM 25	M25	1.00 (25.5)	.06 - .16 (1.5 - 4.0)	.20 - .83 (5.0 - 21.0)	.85 (21.6)	1.18 (30.0)	.45 (11.5)	.29 (7.4)
STM 32	M32	1.28 (32.5)	.06 - .16 (1.5 - 4.0)	.51 - 1.04 (13.0 - 26.5)	1.09 (27.6)	1.46 (37.0)	.45 (11.5)	.34 (8.6)
STM 40	M40	1.59 (40.5)	.06 - .16 (1.5 - 4.0)	.51 - 1.34 (13.0 - 34.0)	1.32 (33.6)	1.77 (45.0)	.59 (15.1)	.34 (8.6)